

5211317-KIT
Quantity as required
for Slots 1 to 21

562136

PCB Designed by
Customer

MSSW15024GD
2 x 200 pin module

562165
3 x 200 pin module
recommended

561897 or
562055

562182

MSSW12524GD
2 x 100 pin module

5211332-KIT
Quantity as required
for slots 22 to 31

COMMENTS / NOTES

 WWW.MACPANEL.COM

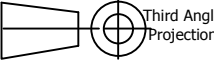
DRAWN BY
davecooper
 DATE
30/04/2015

 Third Angle
Projection
 SHEET
2 OF 4

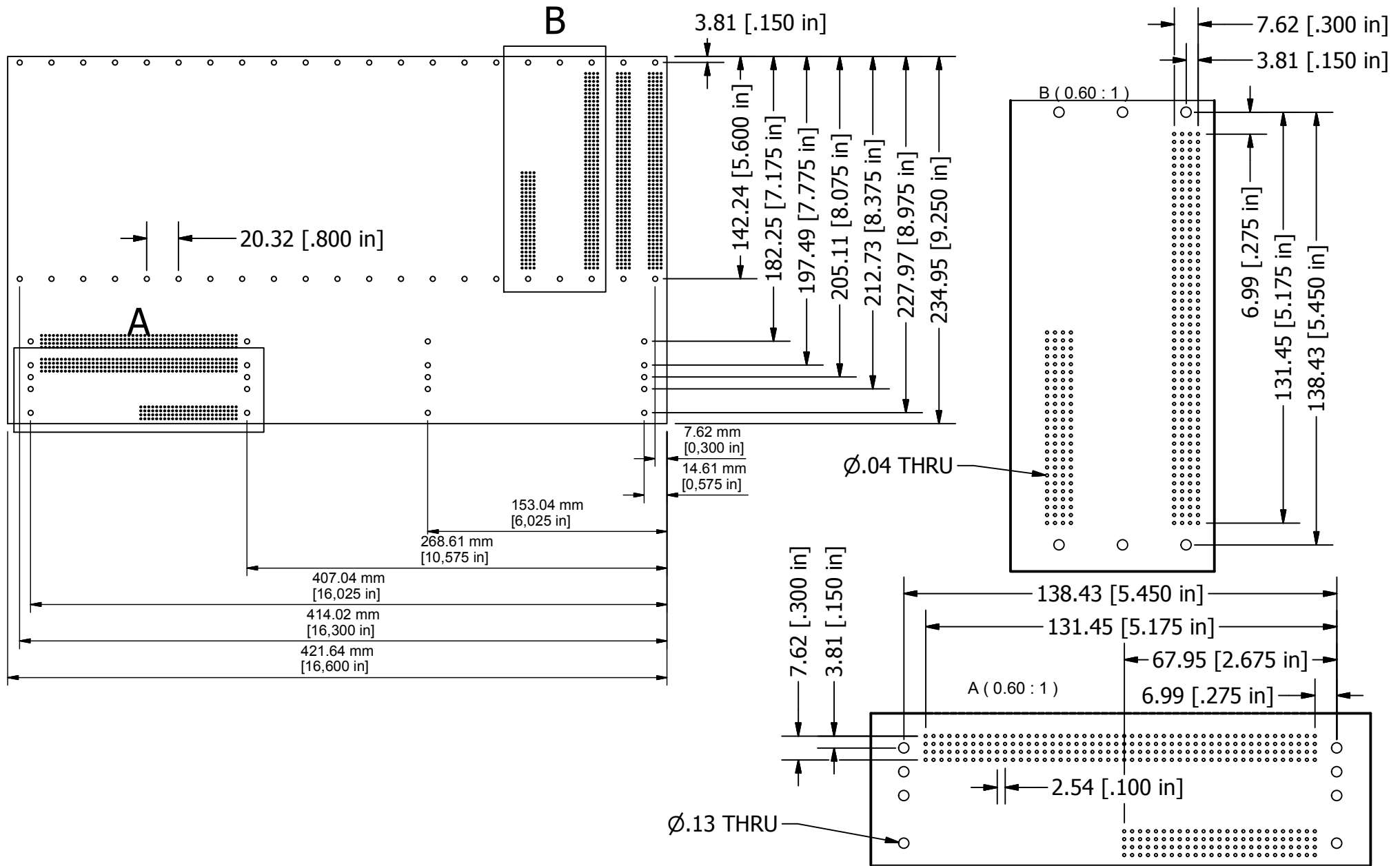
DESCRIPTION
WireFree Example SCOUTxt
 DRAWING NO.
-CU
 REVISION
A



COMMENTS / NOTES

MACPANEL

WWW.MACPANEL.COM

DRAWN BY
davecooper

DATE
30/04/2015

DESCRIPTION

WireFree Example
SCOUTxtExample_PCB_SCOUT_A



SHEET
3 OF 4

DRAWING NO.

example_PCB_SCOUTxt_A-CU

REVISION

A

C-C (0.5)

D-D (0.5)

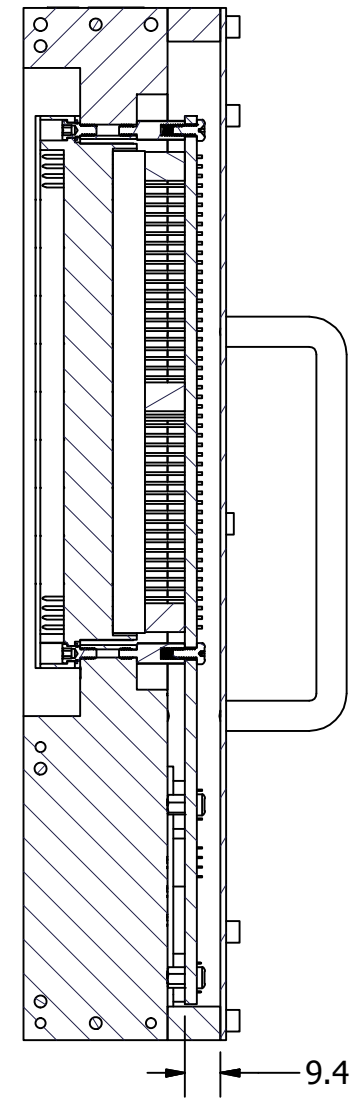
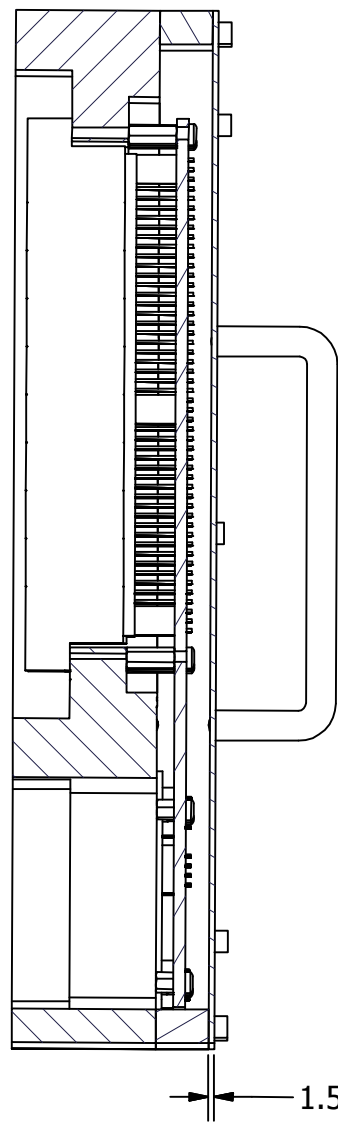
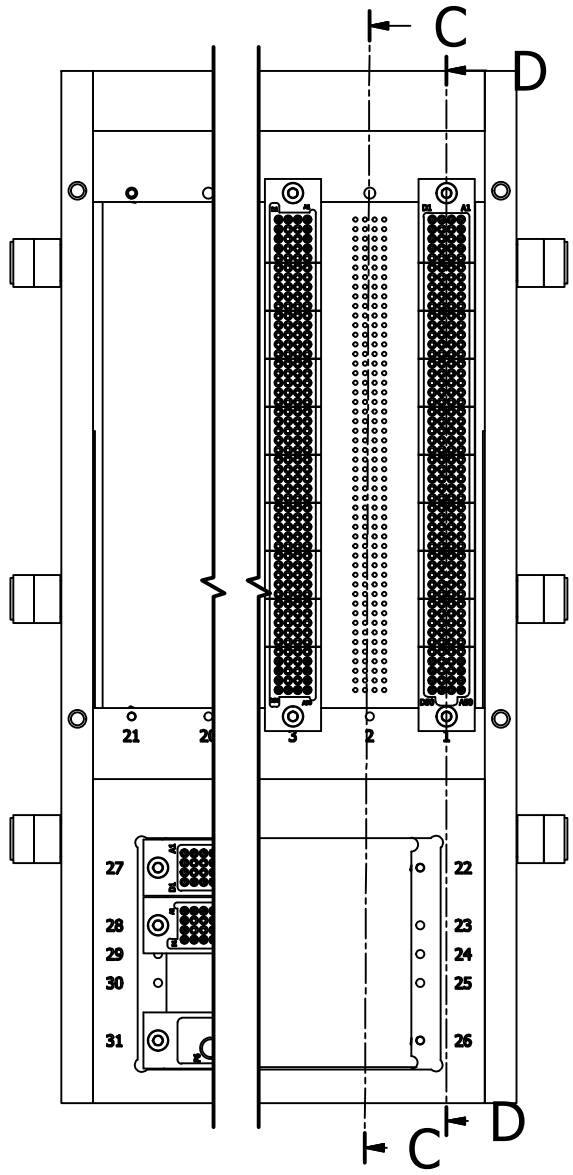

COMMENTS / NOTES

MAC-PANEL

WWW.MACPANEL.COM

DRAWN BY
davecooper

DATE
30/04/2015

DESCRIPTION

WireFree Example SCOUTxt

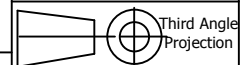

Third Angle
Projection

DRAWING NO.

-CU

REVISION

A

SHEET
4 OF 4