

COMMENTS / NOTES

MAC-PANEL

WWW.MACPANEL.COM

DRAWN BY  
davecooper

DATE  
13/01/2014

DESCRIPTION

Wireless ITA PCB SCOUT



Third Angle  
Projection

DRAWING NO.

ITA\_PCB\_SCOUT-CU

REVISION

B

SHEET  
1 OF 4

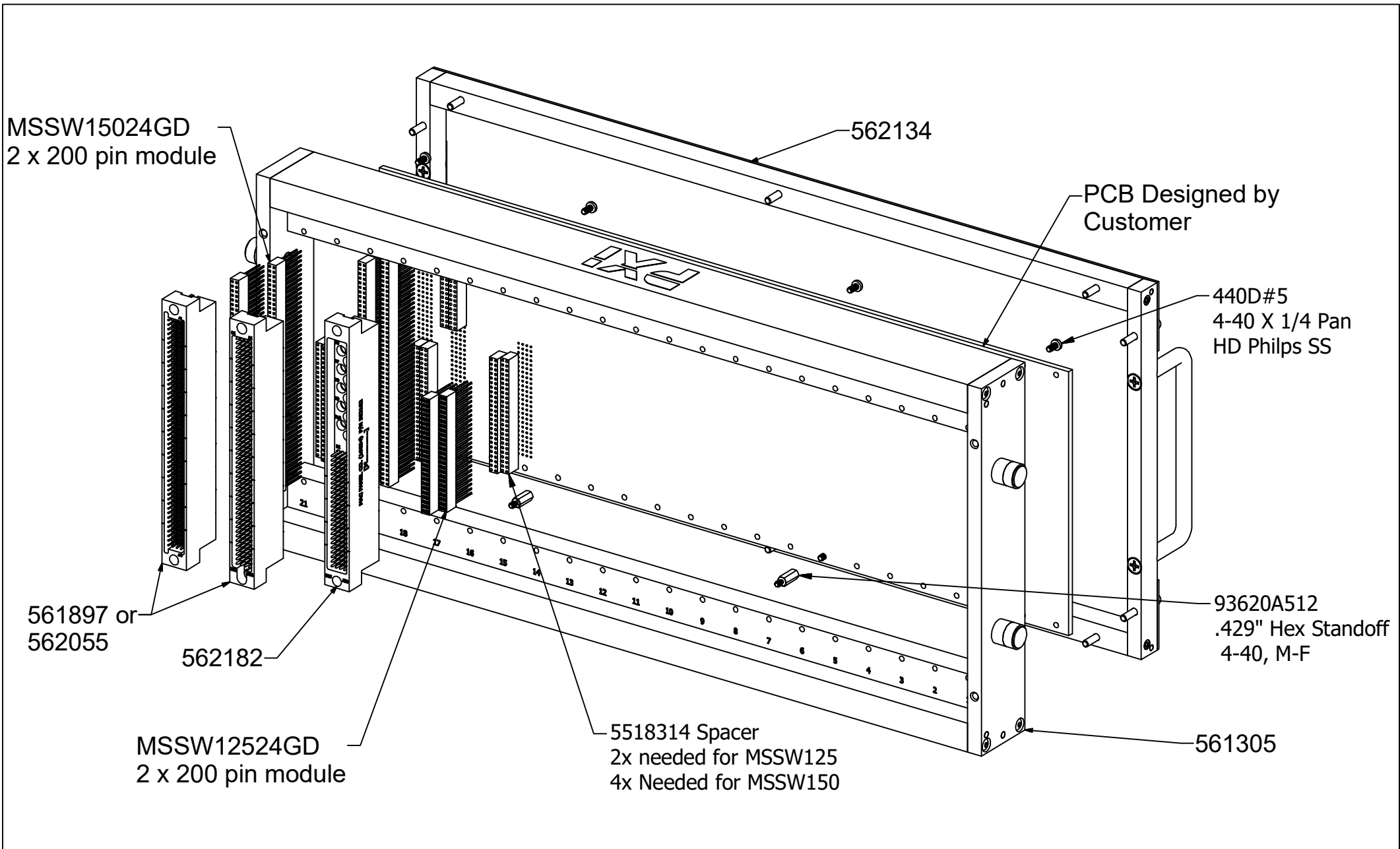

COMMENTS / NOTES  
 1 off 93620A512 Standoff and 1 off 440D#5 screw can be bought as 5210143-Kit

  
 WWW.MACPANEL.COM

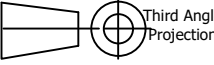
DRAWN BY  
 davecooper  
 DATE  
 13/01/2014  
  
 Third Angle  
 Projection  
 SHEET  
 2 OF 4

DESCRIPTION  
 Wireless ITA PCB SCOUT  
 DRAWING NO.  
 ITA\_PCB\_SCOUT-CU  
 REVISION  
 B

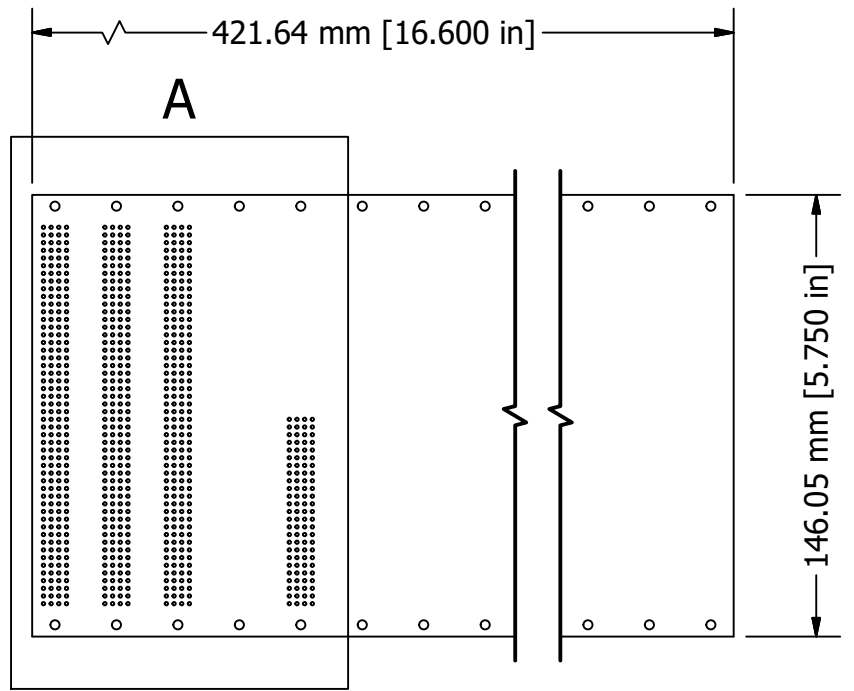
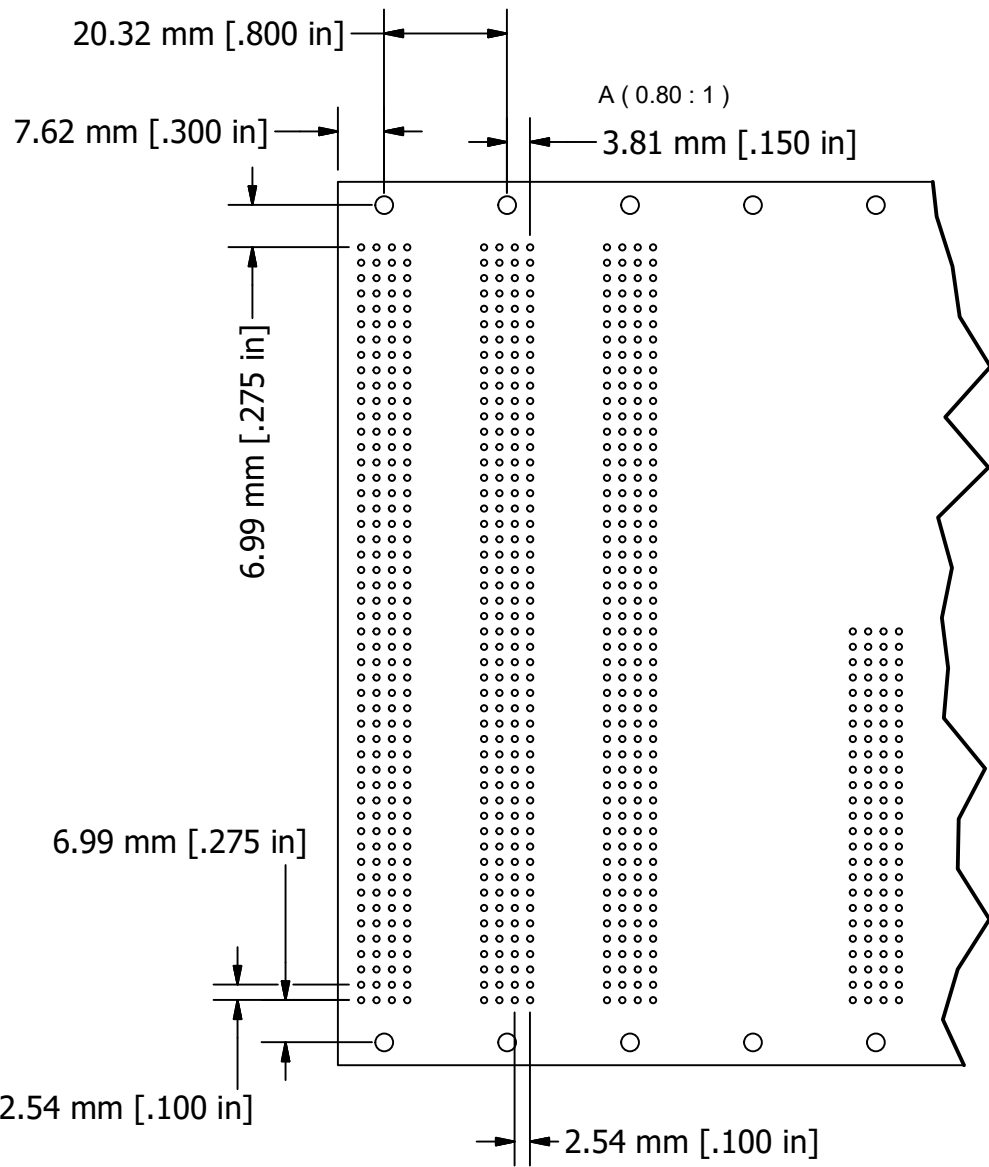

COMMENTS / NOTES

	DRAWN BY davecooper	DATE 13/01/2014	DESCRIPTION Example_PCB_SCOUT_A
	WWW.MACPANEL.COM	 Third Angle Projection	DRAWING NO. example_PCB_SCOUT_A-CU <sup>B</sup>
SHEET 3 OF 4		REVISION	

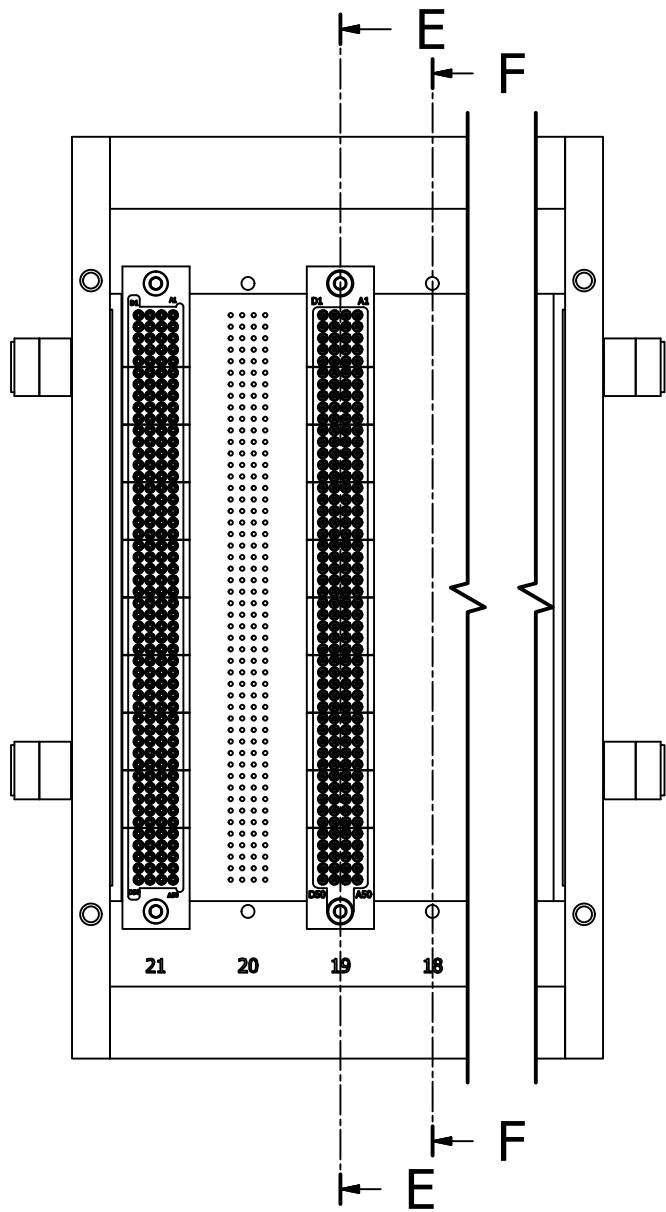

E-E (0.6)

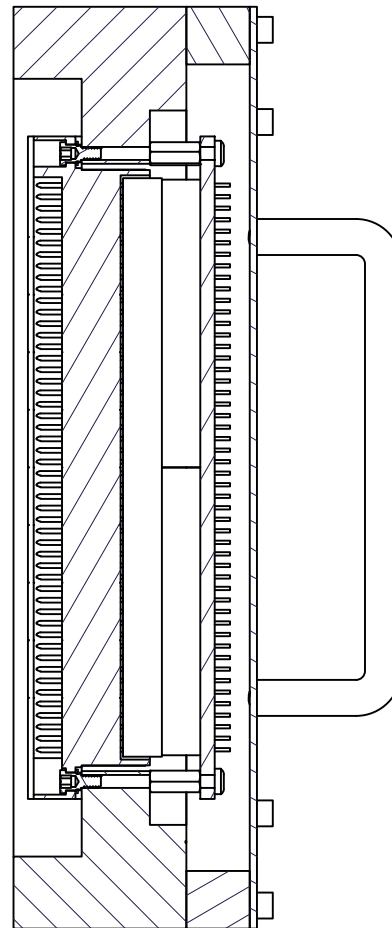

F-F (0.6)

1.52 mm [.060 in]

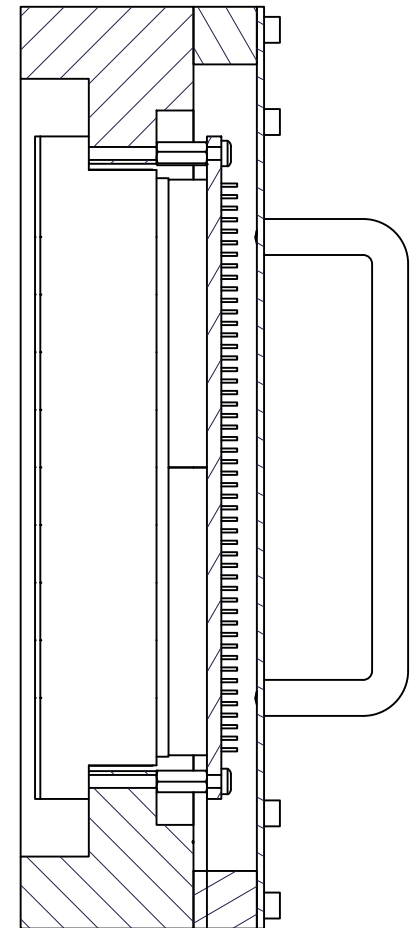

10.99 mm [.433 in]

COMMENTS / NOTES

MAC-PANEL

WWW.MACPANEL.COM

DRAWN BY  
davecooper

DATE  
13/01/2014

DESCRIPTION

Wireless ITA PCB SCOUT

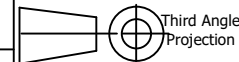

DRAWING NO.

ITA\_PCB\_SCOUT-CU

REVISION

B

SHEET  
4 OF 4